

Connor Hubbard
CSUS 898
July 23, 2020

Impact Project

Chapter 1: “What”

The title of my project is “Agricultural Mechanics & Chemistry” and its goal is to provide a one to two-week high school curriculum focused on the incorporation of state science standards related to chemistry to further explore small engine operation. The purpose of this curriculum is to allow Michigan agriculture, food and natural resources educators to embed state science standards into their work in the agricultural mechanics’ classroom. The need was identified as it can be hard to have diverse course offerings in an agriculture, food and natural resources program at a small school unless you are able to cover state science standards as well.

Chapter 2: “Why”

Covering state science standards adds further justification as to why agriculture, food and natural resources classes should be offered at a high school and allows teachers to offer more opportunities for their students with additional course offerings. According to Parr and Leising (2008) “Many vocational courses are taught simply by showing a student how to perform an operation without properly training the student in the theory supporting it” (p. 61). Agricultural mechanics would be a natural fit to adopt as a course offering, as it can be taught in such a way that can cover content required by Michigan science standards while teaching the traditional topics covered in the realm of agricultural mechanics. Since 2018 the Alcona Agriscience program has offered agricultural mechanics courses and it is the most popular agriculture, food and natural resources course offering at Alcona Community Schools. Additionally, most of the large employers in the northeastern Lower Peninsula of Michigan specialize in trades that require employees to have hands-on mechanical knowledge and experience which highlights the importance that “we need to continually update and evolve our curriculum to prepare our students for the jobs they will eventually get” (Solomonson, 2015, p.10).

Parr, B.A., Leising, J.G. (2008). Does a Curriculum Integration Intervention To Improve The Mathematics Achievement of Students Diminish Their Acquisition of Technical Competence? An Experimental Study in Agricultural Mechanics. *Journal of Agricultural Education*, 49(1), 61-71.

Solomonson, J. (2015). Is Agricultural Mechanics Still Relevant in Today's High Schools?. *The Agricultural Education Magazine*, 87(4), 9-10.

Chapter 3: “How”

The first step in developing this curriculum was to evaluate the Michigan High School Science Standards. Similar work in this area has been done before by the AG-STEM Education Research Lab where the importance was realized that: “agricultural education provides an avenue where science education is applied in meaningful ways. For quite some time now, there has been an emphasis placed on aligning science concepts with agriculture curricula” (p. 1). For this specific project seven standards (HS-PS-1, HS-PS1-2, HS-PS1-3, HS-PS1-4, HS-PS1-5, HS-PS3-1 and HS-PS3-2) were chosen as they relate to both chemistry and their principles can be applied to small engine operation. From there, the standards were organized into four lessons relating the concepts relayed in the standards to the agricultural mechanics’ classroom. Lessons and content were developed from research and experiences had by Connor Hubbard from his teaching and professional development opportunities.

AG-STEM Education Research Laboratory. (2015). *A Framework for Agricultural STEM Education*. University of Florida.

Chapter 4: “Results”

See attached to this report.

Chapter 5: “So What”

This project can be used by any Michigan agriculture, food and natural resources educator that is looking to either incorporate chemistry standards into their existing agricultural mechanics curriculum or by educator’s that want to justify offering agricultural mechanics as a part of their program, as they can cover core science standards. Beyond just focusing on small engine operation and chemistry principles many core science standards can be taught through agricultural mechanics, future extensions of this project could include additional curriculum focusing beyond the seven state science standards that are covered by this curriculum. In regards to this project more supporting materials for the curriculum could have been added, such as guided note sheets, formative assessments and summative assessments. Time did not allow for all of these components to be added to the curriculum, a lot of focus was put into researching theoretical concepts and trying to apply them to learning opportunities in a hands-on agricultural mechanics’ classroom.

Agricultural Mechanics

Title of Unit:	Ag Mechanics & Chemistry
Title of Lesson:	<i>Introducing Chemistry Concepts</i>
Situation:	<i>This lesson is designed to be applied to an Agricultural Mechanics classroom and is the first lesson in a four lesson series embedding NGSS science standards in agricultural mechanics' curriculum. This lesson will outline chemistry basics for students.</i>
Housekeeping:	<i>Announcements, attendance, reminders, etc.</i>
Objective(s):	Students will be able to identify what matter is, components of an atom, describe how molecules are created, the importance of electrons and bonding and will understand that elements are organized on the periodic table based on a presentation and videos outlining each of these tasks.
CTE Standards:	N/A
Core Standards:	<i>HS-PS1-1 Use the periodic table as a model to predict the relative properties of elements based on the patterns of electrons in the outermost energy level of atoms.</i>
Materials:	<i>Students:</i> <ul style="list-style-type: none">○ <i>Note-taking materials</i> <i>Teacher:</i> <ul style="list-style-type: none">○ <i>Introducing Chemistry Concepts Slides Presentation</i>○ <i>Computer with internet connectivity</i>○ <i>Projector and Projection Screen</i>○ <i>Speakers to share videos</i>
References:	<i>Specific texts, web sites etc. (so you can find it)</i> <i>Video: Understanding the Periodic Table -</i> https://www.youtube.com/watch?v=kaeDZmPJMbY <i>Video: What are Elements? -</i> https://www.youtube.com/watch?v=atcrgTH_ul4 <i>Video: Chemical Bonding – Ionic vs. Covalent Bonds –</i> https://www.youtube.com/watch?v=OTgpN62ou24 <i>Video: Carbon: The Element of Life -</i> https://www.youtube.com/watch?v=ULiLt2rtpAg

Interest Approach:

Place an object at the front of the room that might be attention grabbing. Ask students what it is and go further asking what it is made out of. Scaffold students to get to a point where they may identify any knowledge they have of atoms.

Student/Teacher Planning:

What is the Problem?

Students are not familiar with chemistry principles and will need to learn about chemistry standards.

Why is it important we solve it?

Chemistry standards need to be covered in order to meet high school graduation guidelines. Additionally, chemistry is a basis to many science principles.

How should we solve it?

Discuss and practice chemistry principles in a way related to learning in the Agricultural Mechanics classroom.

Problem Solution:

How you teach it and what you teach

Teacher Task	Instructions/Guidance
Interest Approach (5 minutes)	Place an object at the front of the room that might be attention grabbing. Ask students what it is and go further asking what it is made out of. Scaffold students to get to a point where they may identify any knowledge they have of atoms
Student/Teacher Planning (5 minutes)	After working students through the interest approach, discuss chemistry with them and gain their knowledge. Most will probably express limited knowledge validating the lesson to learn more about chemistry
Introducing Chemistry Concepts Presentation - Google Slides (45 minutes)	Work through this 17 slide presentation with students. Four videos are embedded to aid in their understanding. Students are expected to take notes, teacher will hone in on specific topics of importance for their student to learn.

Applying Solutions:

How students can practice what you taught: Students will apply concepts from this lesson in consecutive lessons to understand how chemistry works.

Evaluation:

How you assess what they learn: Students can be asked to describe atoms, molecules, elements and the importance of

electrons. This could be done as an assignment, formative assessment or be asked on a test.

AG MECHANICS & CHEMISTRY

Lesson 1

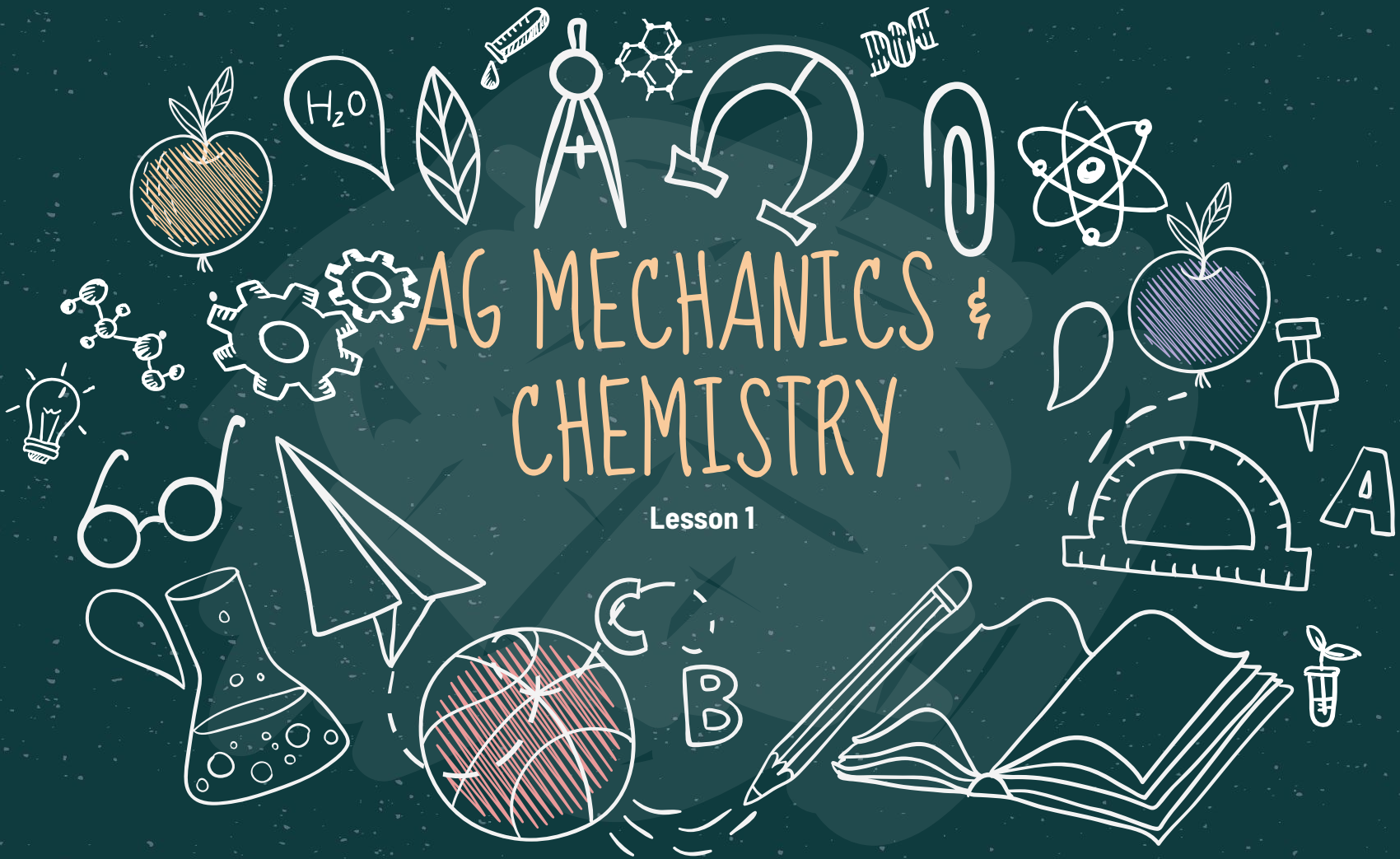

THE GOAL OF THIS PRESENTATION:

Accomplish this Standard:

HS-PS1-1 Use the periodic table as a model to predict the relative properties of elements based on the patterns of electrons in the outermost energy level of atoms.

1. Understand:
 - a. Matter
 - b. Elements
 - c. Atoms
 - d. Molecules
 - e. Electrons
 - f. The Periodic Table
 - g. The Importance of Carbon

$\sqrt{123}$

INTRODUCING CHEMISTRY CONCEPTS



STUDY
HARD!

+ x ÷

WHAT IS CHEMISTRY?



"Chemistry is the study of matter, its properties, how and why substances combine or separate to form other substances and how substances interact with energy."

-LIVE SCIENCE

<https://www.livescience.com/45986-what-is-chemistry.html>

SO WHAT IS MATTER? AND HOW DOES IT WORK?



01

MATTER

Can be anything that has mass or weight and takes up space - even if that space is microscopic!

02

ATOMS

Make up matter and are the smallest particles of an element, they are made up of electrons, protons and neutrons.



03

ELEMENTS

Consist of one type of atoms, they cannot be broken down into anything else.

04

MOLECULES

Matter that is made up of 2 or more atoms or elements that are combined together are molecules.

WHAT DOES AN ATOM LOOK LIKE?



ELECTRONS

Negatively charged and rotate around the outside of the atom.

NEUTRONS

Neutral (no charge) and make up the nucleus with protons.

PROTONS

Positively charged and make up the nucleus with the neutrons.

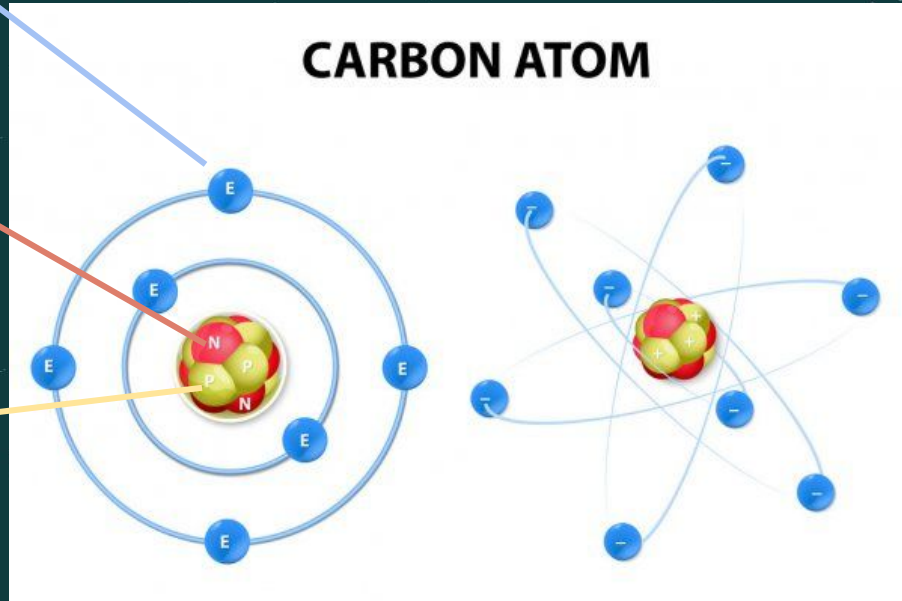

Both pictures in the diagram are examples of a Carbon atom, the one on the left is more simple. The model on the right is just demonstrating what an atom looks like with the electrons rotating around the nucleus.

In your own notes create your own diagram of an atom!

ELECTRONS!!!!

WHY IS THIS STRUCTURE IMPORTANT?



It all boils down to the electrons!

Electrons in the “outer shell” of the atom are called valence electrons and they allow for bonding to occur between atoms. Which creates molecules - 2 or more atoms bonded together.

Let's hold on to this thought...

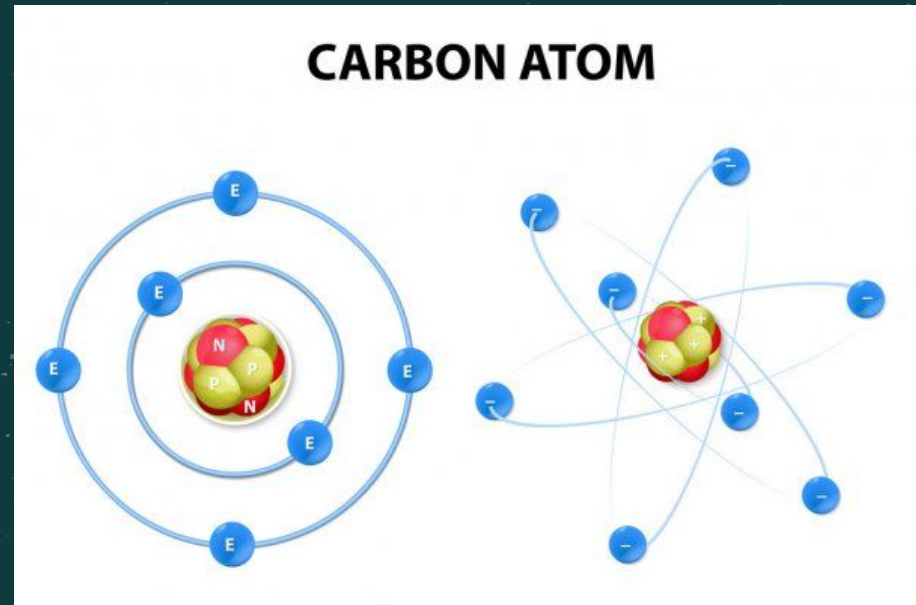

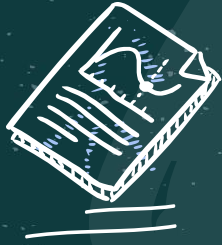

SO HOW MANY
ATOMS OR
ELEMENTS ARE
THERE?

Periodic Table of the Elements

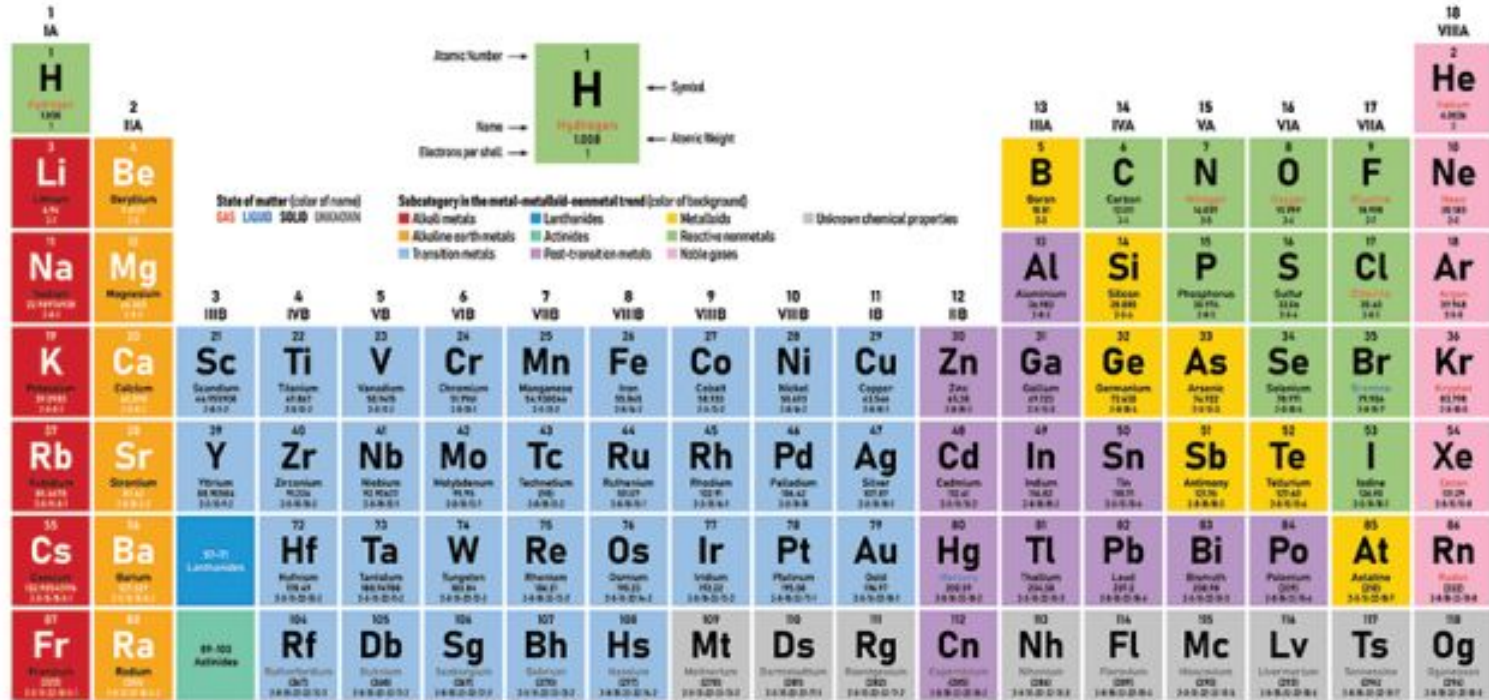

118

WHAT IS THE MEANING OF THE PERIODIC



It can actually be pretty tricky to explain. Let's take a look at a video to get a better understanding:

Understanding the Periodic Table

Periodic Table of the Elements

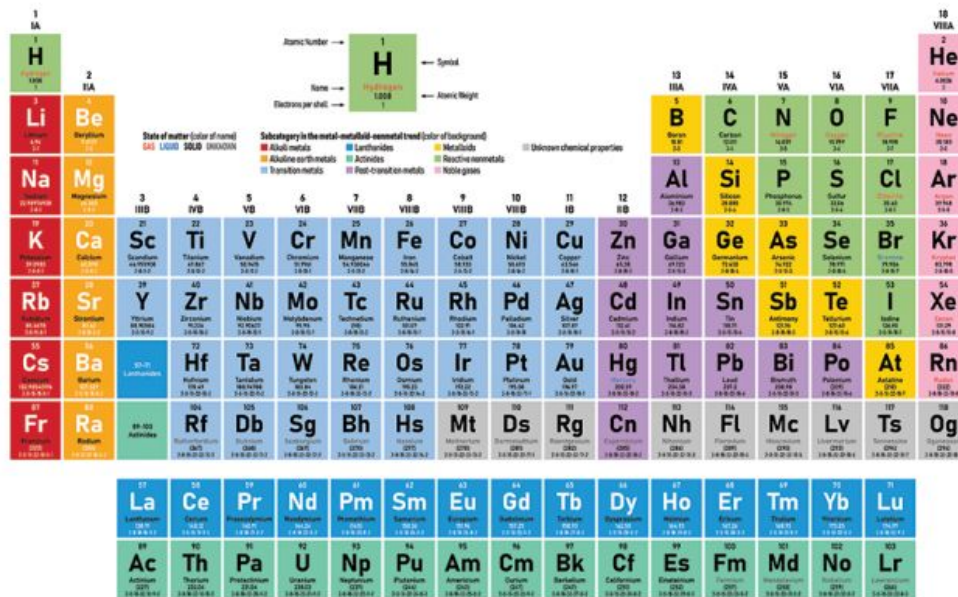

WHY DOES
THIS ALL
MATTER?





ELEMENTS MAKE UP
EVERYTHING!

LET'S TAKE A DEEPER LOOK INTO ELEMENTS

[What are Elements?](#)

2:50 Video





HOW ARE THE THINGS WE SEE
CREATED?

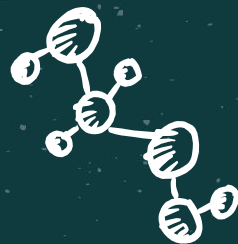

ELEMENTS COMBINED TOGETHER ARE MOLECULES



Large molecules become matter we can see and in some cases feel. We are made out of elements that are combined together to make molecules.

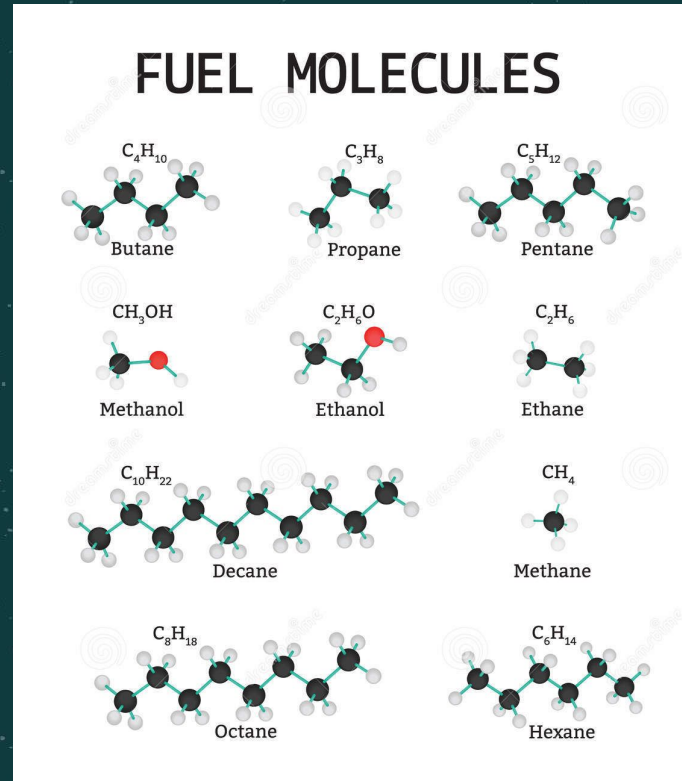

In this picture we can see that **Carbon** is bonding with Hydrogen and in some cases both Hydrogen and Oxygen to form molecules that we would find in fuel. How do these bonds occur:

[Chemical Bonding - Ionic vs. Covalent Bonds](#) - 2:14
Video

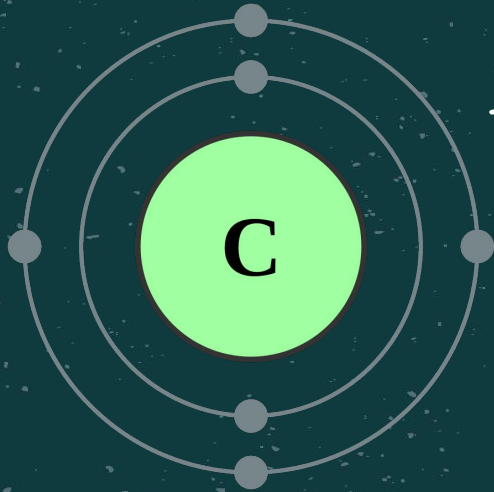

TURNS OUT CARBON IS PRETTY IMPORTANT:

Carbon: The Element of Life - 2:57 Video

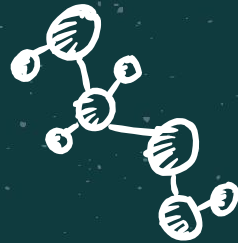

☆
 $\sqrt{123}$



☆
Can you come up with an answer on
How Ag Mechanics and Chemistry
could be related?
☆

STUDY
HARD!

+x÷

☆
Work with a group to come up with an answer or record your response in your notes!

Agricultural Mechanics

Title of Unit:	Ag Mechanics & Chemistry
Title of Lesson:	<i>Characterizing Reactions & Combustion</i>
Situation:	<i>This lesson is designed to be applied to an Agricultural Mechanics classroom and is the second lesson in a four lesson series embedding NGSS science standards in agricultural mechanics' curriculum. This lesson will outline the basics of chemical reactions and specifically detail the reaction of fuel combustion.</i>
Housekeeping:	<i>Announcements, attendance, reminders, etc.</i>
Objective(s):	Students will be able to describe chemical reactions and how they take place and explain how the combustion reaction takes place based on a presentation, videos and a lab experience.
CTE Standards:	N/A
Core Standards:	<i>HS-PS1-2 Construct and revise an explanation for the outcome of a simple chemical reaction based on the outermost electron states of atoms, trends in the periodic table, and knowledge of the patterns of chemical properties.</i> <i>HS-PS1-3 Plan and conduct an investigation to gather evidence to compare the structure of substances at the bulk scale to infer the strength of electrical forces between particles.</i> <i>HS-PS1-4 Develop a model to illustrate that the release or absorption of energy from a chemical reaction system depends upon the changes in total bond energy.</i>
Materials:	<i>Students:</i> <ul style="list-style-type: none">○ <i>Note-taking materials</i> <i>Teacher:</i> <ul style="list-style-type: none">○ <i>Characterizing Reactions & Combustion Slides Presentation</i>○ <i>Computer with internet connectivity</i>○ <i>Projector and Projection Screen</i>○ <i>Speakers to share videos</i>○ <u><i>Lab Materials</i></u>

- *Glass Container in the shape of a cylinder with a top or lid*
- *Small dropper*
- *Gasoline*
- *Two Beakers*
- *Rubber stopper*
- *Ignition Source (Matches)*
- *PPE*

References:

Video: Amazing Chemical Reactions -

<https://www.youtube.com/watch?v=FofPjj7v414>

Video: Gasoline Combustion -

<https://www.youtube.com/watch?v=Vca0iuBwpVg>

Text: Radcliffe, B.R. (2016). Small Engines. American Technical Publishers

Interest Approach:

Embedded within the presentation – show the “Amazing Chemical Reactions” video to students and discuss with them after the video on how these things took place.

Student/Teacher Planning:

What is the Problem?

Students are not familiar with chemical reactions and will need to learn about chemistry standards.

Why is it important we solve it?

Chemistry standards need to be covered in order to meet high school graduation guidelines. Additionally, chemistry is a basis of many science principles.

How should we solve it?

Discuss and practice chemistry principles in a way related to learning in the Agricultural Mechanics classroom.

Problem Solution:

How you teach it and what you teach

Teacher Task	Instructions/Guidance
Interest Approach (5 minutes)	Embedded within the presentation – show the “Amazing Chemical Reactions” video to students and discuss with them after the video on how these things took place.
Student/Teacher Planning (5 minutes)	After working students through the interest approach, discuss chemical reactions to gauge their familiarity with them. Reference and ask if the running of an engine is a chemical reaction.

Characterizing Chemical Reactions Presentation - Google Slides (25 minutes)	Work through this 15 slide presentation with students. Two videos are embedded, one to show examples of chemical reactions (interest approach) and one that should be shown up to 2:10 to show an example of gasoline combustion before practicing a similar lab. Students are expected to take notes, teacher will hone in on specific topics of importance for their student to learn.
--	--

Applying Solutions: *How students can practice what you taught*

Teacher Task	Instructions/Guidance
Gasoline Combustion Lab (20 minutes)	Follow the protocol described in the “Gasoline Combustion Lab” document. This lab will represent the combustion reaction and allow students to see the reaction take place first hand.

Evaluation: *How you assess what they learn: Students can be asked to describe the combustion reaction and what the reactants and products are. This could be done as an assignment, formative assessment or be asked on a test.*

AG MECHANICS & CHEMISTRY

Lesson 2

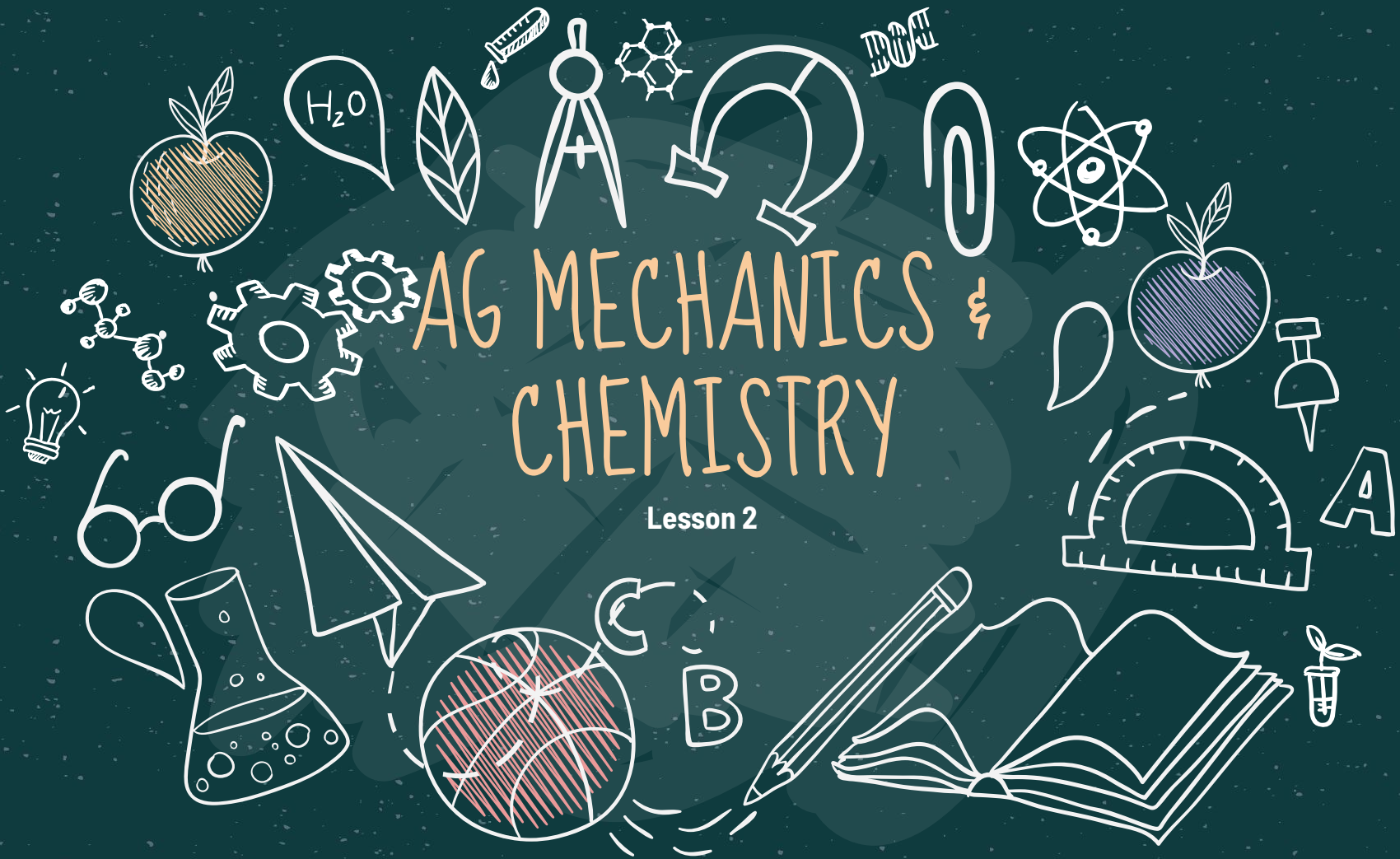

THE GOAL OF THIS PRESENTATION:

Accomplish these Standards:

HS-PS1-2 Construct and revise an explanation for the outcome of a simple chemical reaction based on the outermost electron states of atoms, trends in the periodic table, and knowledge of the patterns of chemical properties.

HS-PS1-3 Plan and conduct an investigation to gather evidence to compare the structure of substances at the bulk scale to infer the strength of electrical forces between particles.

HS-PS1-4 Develop a model to illustrate that the release or absorption of energy from a chemical reaction system depends upon the changes in total bond energy.

1. Be able to:
 - a. Describe chemical reactions
 - b. Explain how the reaction of combustion works.

☆
 $\sqrt{123}$



CHARACTERIZING REACTIONS & COMBUSTION

STUDY
HARD!







+x÷

WHAT ARE REACTIONS?



Let's See:

[Amazing chemical reactions!](#) Video 4:11



Chemical reaction, a process in which one or more substances, the reactants, are converted to one or more different substances, the products. "A chemical reaction rearranges the constituent atoms of the reactants to create different substances as products."

-ENCYCLOPEDIA BRITANNICA

<https://www.britannica.com/science/chemical-reaction>



SO LET'S TALK ABOUT COMBUSTION!



Combustion reactions happen when a fuel source reacts with oxygen gas (O_2) then releasing energy in the form of heat and light.

[https://chem.libretexts.org/Bookshelves/Introductory_Chemistry/Book%3A_Introductory_Chemistry_\(CK-12\)/11%3A_Chemical_Reactions/11.6%3A_Combustion_Reactions#:~:text=A%20combustion%20reaction%20is%20a,hydrogen%20gas%20produces%20water%20vapor.&text=Notice%20that%20this%20reaction%20also%20qualifies%20as%20a%20combination%20reaction.](https://chem.libretexts.org/Bookshelves/Introductory_Chemistry/Book%3A_Introductory_Chemistry_(CK-12)/11%3A_Chemical_Reactions/11.6%3A_Combustion_Reactions#:~:text=A%20combustion%20reaction%20is%20a,hydrogen%20gas%20produces%20water%20vapor.&text=Notice%20that%20this%20reaction%20also%20qualifies%20as%20a%20combination%20reaction.)

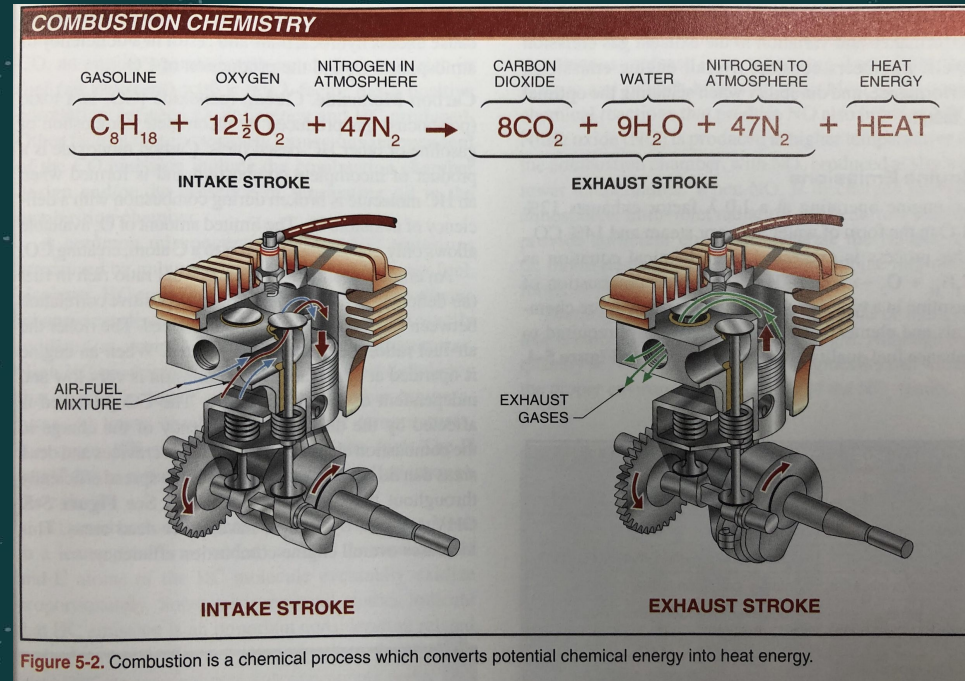

Figure 5-2. Combustion is a chemical process which converts potential chemical energy into heat energy.

Radcliffe, B.R. (2016). *Small Engines*. American Technical Publishers.

HYDROGEN

In this instance each hydrogen atom is making one bond to carbon - filling up its outer electron shell.

CARBON

Each carbon atom has four bonds, allowing it to fill up its outer electron shell.

REACTANT - GASOLINE (C₈H₁₈)

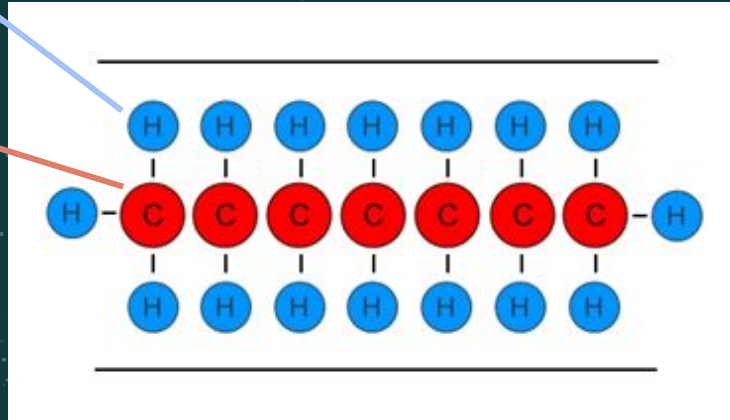

Gasoline is the most common fuel for small engines applications. It is a hydrocarbon, meaning it is molecule made out of carbon and hydrogen. Hydrocarbons are held together by loose bonds allowing for energy to be easier to be released from them.

In your own notes create your own diagram of an gasoline!

WHY IS GASOLINE BONDED LIKE THIS?

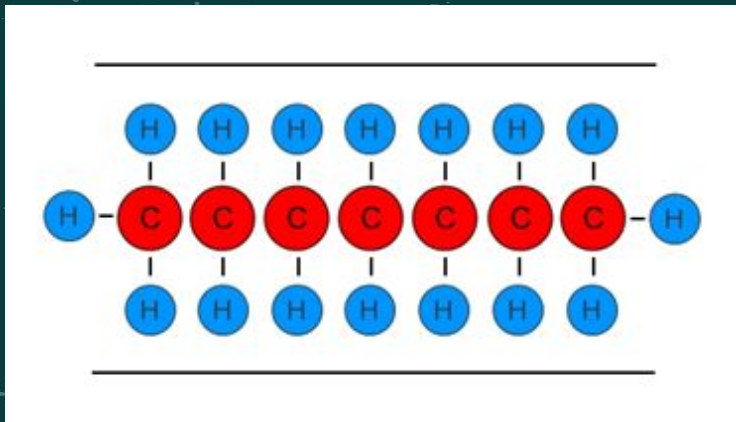

HYDROGEN

Hydrogen only has one electron and only one shell to hold electrons. The first shell for all atoms only holds two electrons at most, so hydrogen will only bond once with another atom.

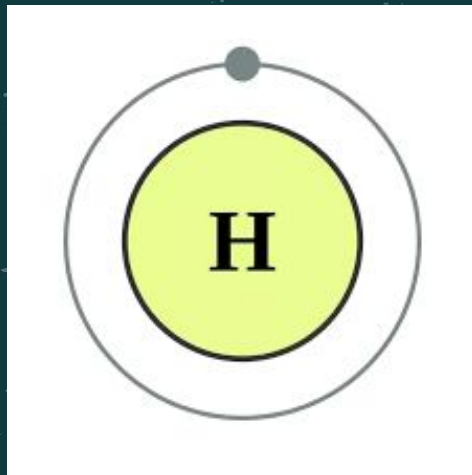

CARBON

Besides the exception of Hydrogen all atoms like to have eight electrons, making them more stable. Therefore carbon likes to form four bonds to fill up its outer electron shell.

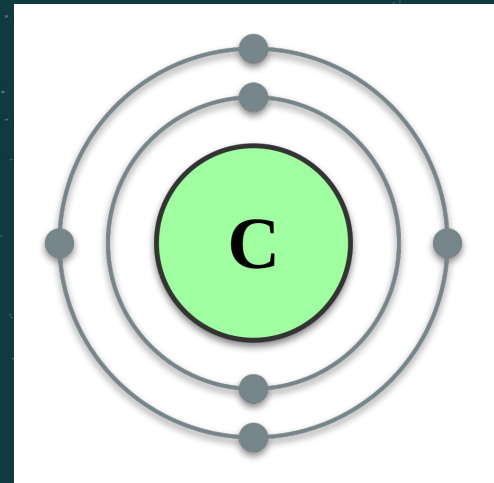

HOW DOES OUR CHEMICAL REACTION OCCUR?



01

REACTANTS

Gasoline, Oxygen gas and Atmospheric nitrogen are mixed together

02

IGNITION

The reactants are then ignited. During ignition the hydrocarbons in gasoline start to fragment breaking chemical bonds.

03

PRODUCTS

The breaking of bonds in ignition allows for oxygen to bond with hydrogen and carbon atoms - creating our products.

04

ENERGY

Besides new chemical compounds being formed energy is also released in the form of heat.

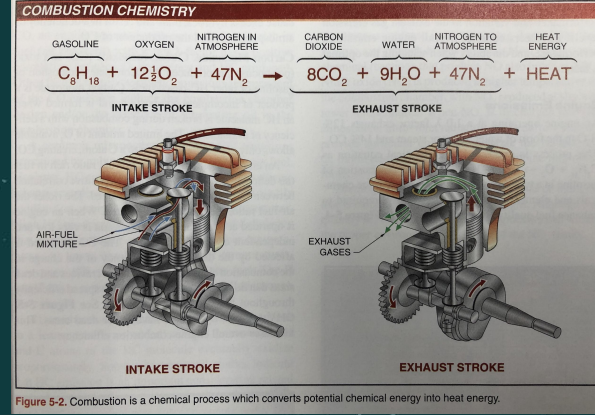
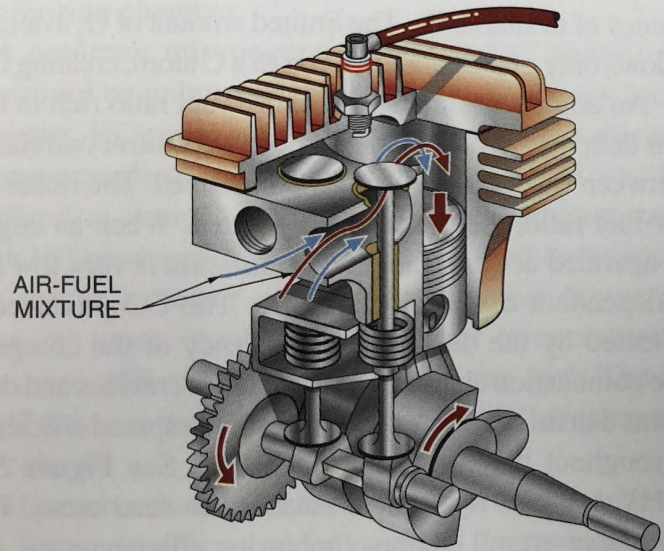
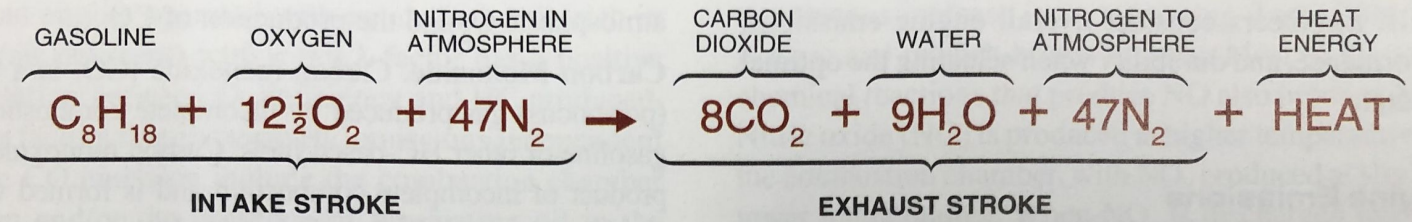

Figure 5-2. Combustion is a chemical process which converts potential chemical energy into heat energy.



Notice how the reaction is balanced - meaning that the same amount of each atom is present before and after the reaction.

COMBUSTION CHEMISTRY



INTAKE STROKE

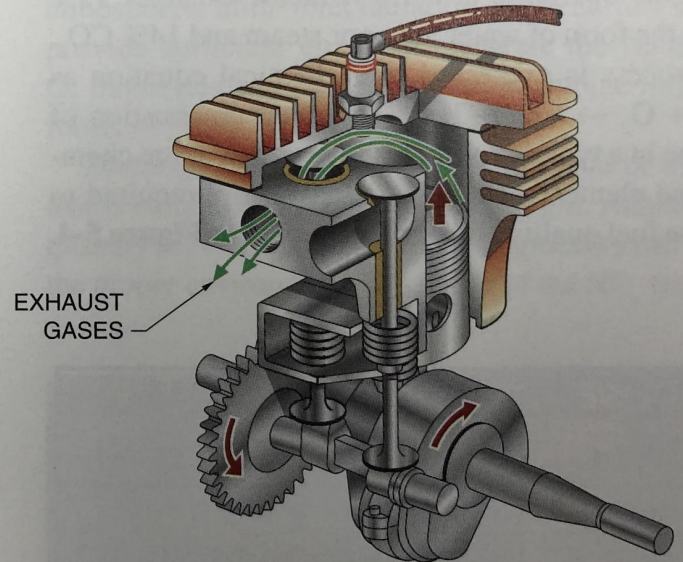

EXHAUST STROKE

Figure 5-2. Combustion is a chemical process which converts potential chemical energy into heat energy.

REVIEW OF COMBUSTION



So overall we take gasoline and oxygen with atmospheric nitrogen included, which ignited creates carbon dioxide, water and heat which again includes atmospheric nitrogen as well.

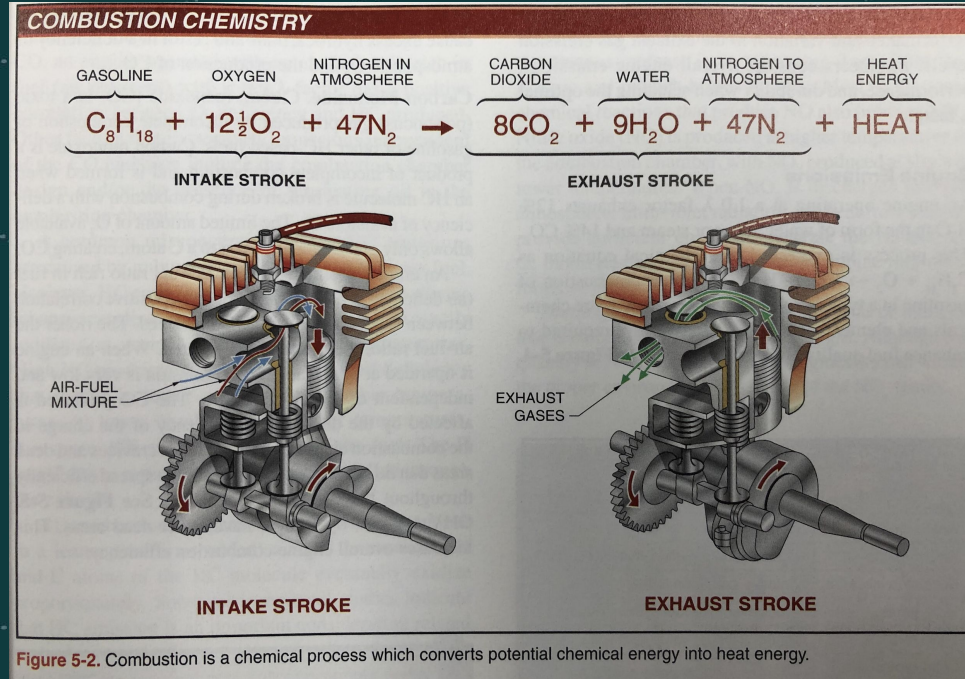

Radcliffe, B.R. (2016). *Small Engines*. American Technical Publishers.

IS IT JUST AS SIMPLE AS ADDING FUEL?

The answer is no. A carburetor is needed to turn the fuel into vapor and then mix it with air to allow for combustion to happen.



CARBURETOR FUNCTION

CARBURETOR OPERATION PRINCIPLES

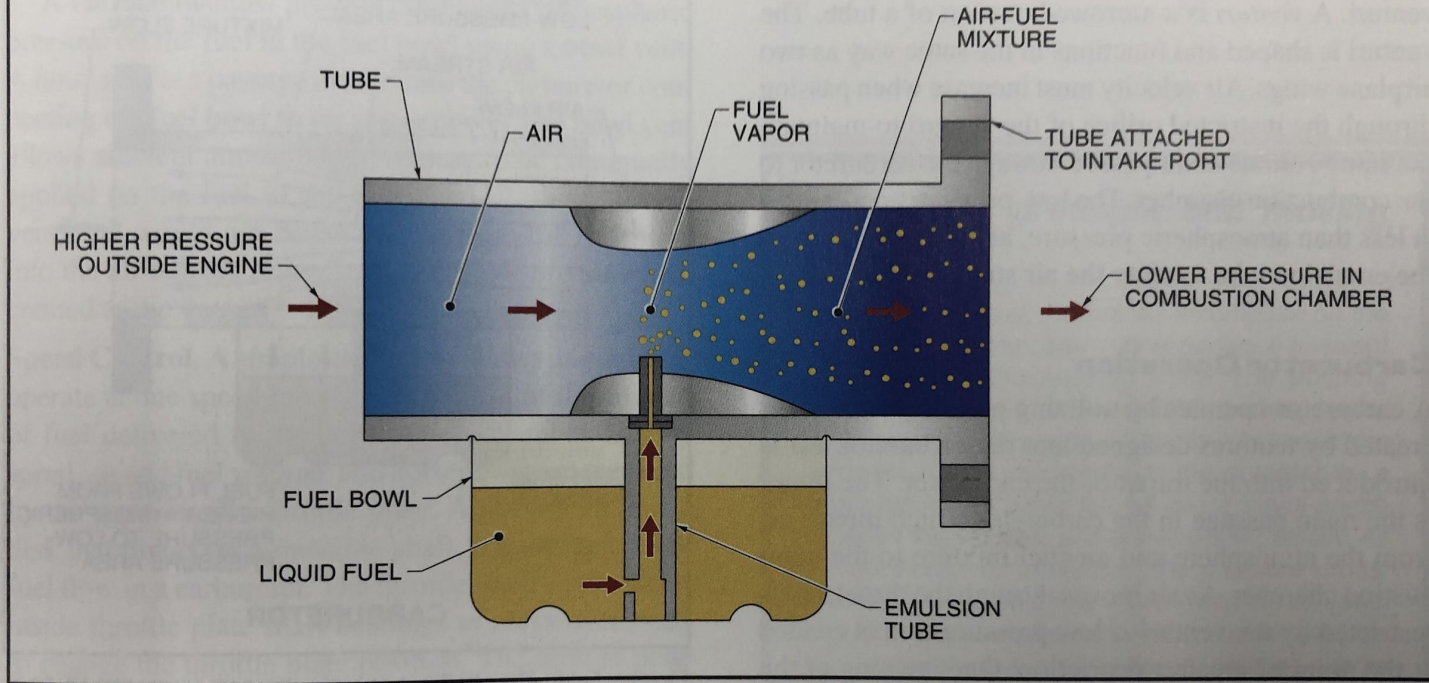
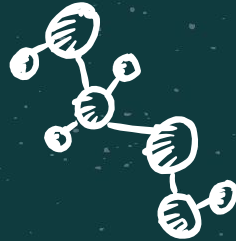

Figure 5-12. In a carburetor, air moves from the area of higher pressure outside the engine to the area of lower pressure inside the combustion chamber.



LET'S PUT IT INTO PRACTICE,
DEMONSTRATION TIME!

Video watch until 2:10: [Gasoline Combustion](#)



☆

$$\sqrt{123}$$



That's a wrap on this lesson! We will
be talking more about fuel next
time!

☆

STUDY
HARD!

☆

+ x ÷

Gasoline Combustion Lab

Materials Needed:

- Glass Cylinder with a lid
 - Example: to test this lab I used a 16 fl oz glass water bottle - I would recommend using a larger glass container for class demonstrations.
- Rubber Stopper
 - Needs to be a size that will fit in your glass cylinder and can be shaken inside the cylinder
- Dropper
- Gasoline
 - Will only use a small quantity
- Two Beakers
 - 250 mL or smaller should suffice
- Ignition Source
 - Matches are best so they can be dropped upon ignition
- PPE
 - Safety Glasses
 - Welding Glove or Fireproof glove to hold ignition source
 - Additional may be required depending on your lab set-up.
-

Instructions:

1. Place your glass cylinder on a flat level surface clear of any flammable materials.
 - a. This represents the cylinder of an engine where combustion will occur
2. Place your rubber stopper into the glass cylinder
 - a. The rubber stopper acts like a pseudo carburetor in the fact that it will mix air with the fuel.
3. Gasoline will need to be in one of the beakers
4. Take a dropper and place drops of gasoline into the cylinder
 - a. The amount of drops will vary due to the container size, for a 16 fl oz container 5 drops suffices.

5. Close the lid on the cylinder and shake the cylinder with the stopper in it - the goal is to vaporize the fuel.
6. Check for any liquid gasoline left and discard into the second beaker.
7. Carefully light a match and ignite the mixture in the cylinder.
8. The mixture will ignite and the combustion reaction will have occurred.

Agricultural Mechanics

- Title of Unit:** Ag Mechanics & Chemistry
- Title of Lesson:** *Understanding Fuel Conditions*
- Situation:** *This lesson is designed to be applied to an Agricultural Mechanics classroom and is the third lesson in a four lesson series embedding NGSS science standards in agricultural mechanics' curriculum. This lesson will outline the basics of carburetor function and the process in how gasoline can "go bad".*
- Housekeeping:** *Announcements, attendance, reminders, etc.*
- Objective(s):** Students will be able to identify how gasoline can go bad or oxidize and the function of a carburetor and how bad gasoline can hinder that function.
- CTE Standards:** N/A
- Core Standards:** *HS-PS1-5 Apply scientific principles and evidence to provide an explanation about the effects of changing the temperature or concentration of the reacting particles on the rate at which a reaction occurs.*
- Materials:**
- Students:*
- *Note-taking materials*
- Teacher:*
- *Understanding Fuel Conditions Slides Presentation*
 - *Reading: "Does Gasoline Go Bad?" print enough copies for student class size*
 - *Computer with internet connectivity*
 - *Projector and Projection Screen*
 - *Speakers to share videos*
 - *Lab Materials*
- References:**
- Video: Does Gasoline Go Bad? -*
<https://www.livescience.com/58117-does-gasoline-go-bad.html?jwsourc=c1>
- Video: How Carburetor Works – Main Fuel System -*
<https://www.youtube.com/watch?v=bVosMNHUObk>

Reading – adapted to Google Doc accessed at - <https://www.livescience.com/58117-does-gasoline-go-bad.html?jwsourc=c1>

Interest Approach:

Place a carburetor or small engine at the front of the room and ask students about how fuel would function with the carburetor or engine. Ask them if it is possible to have bad fuel/gasoline.

Student/Teacher Planning:

What is the Problem?

Students are not familiar with the processes of a carburetor/fuel delivery in a small engine and problems that occur with bad gas.

Why is it important we solve it?

Small engines are a part of everyday life. Additionally, chemistry practices are involved in fuel delivery and the creation of bad gas allowing Chemistry standards to be taught that are required in order to meet high school graduation guidelines. Additionally, chemistry is a basis of many science principles.

How should we solve it?

Discuss the occurrence of bad gas and practice working with a carburetor while applying chemistry principles in the Agricultural Mechanics classroom.

Problem Solution:

How you teach it and what you teach

Teacher Task	Instructions/Guidance
Interest Approach (5 minutes)	Place a carburetor or small engine at the front of the room and ask students about how fuel would function with the carburetor or engine. Ask them if it is possible to have bad fuel/gasoline.
Student/Teacher Planning (5 minutes)	After working students through the interest approach, discuss that fuel delivery in an engine can be complicated and that fuel does not always remain in a useable state.
“Does Gas Go Bad?” Reading (15 minutes)	Initiate a class discussion on if students think if gas can “go bad” record thoughts and viewpoints. At the conclusion of the discussion pass out copies of the reading to students and ask them to read it and record their thoughts.
Understanding Fuel Conditions Presentation - Google Slides	Work through this 11 slide presentation with students. Two videos are embedded, one to

(15 minutes)	support the class reading about bad gas and one that should be shown up to 2:10 to show an example of carburetor operation basics before proceeding to working with a carburetor in a lab environment. Students are expected to take notes, teacher will hone in on specific topics of importance for their student to learn.
--------------	---

Applying Solutions:

How students can practice what you taught

Teacher Task	Instructions/Guidance
Carburetor Function Lab (20 minutes)	Follow the protocol described in the “Carburetor Function Lab” document. This lab will represent how a carburetor functions normally, but also allow for the manipulation of carburetor passageways to represent the use of “bad gas.”

Evaluation:

How you assess what they learn: Students can be asked to describe carburetor function and the implications bad gas can have on this function. This could be done as an assignment, formative assessment or be asked on a test.

Does Gasoline Go Bad?

By Marissa Shieh - Live Science Contributor March 04, 2017

Accessed at: <https://www.livescience.com/58117-does-gasoline-go-bad.html>

Has it been a while since you moved your car? Do you have leftover fuel in your garage for the lawn mower? If so, you may wonder, does gasoline go bad?

Unfortunately, "there's no hard and fast rule," said James Speight, an energy consultant and author of the "Handbook of Petroleum Refining" (Taylor & Francis, 2016) and other publications. "It's just ...very difficult to generalize."

While gasoline can likely keep for months to years, environmental factors such as heat, oxygen and humidity influence the fuel's condition, Speight said. [Hyperloop, Jetpacks & More: 9 Futuristic Transit Ideas]

But if crude oil lasts hundreds of millions of years underground, why is gasoline even at risk of spoiling? Simply put, by the time gasoline reaches consumers, it is a very different substance from the original crude oil.

Gasoline is mostly a mixture of carbon and hydrogen atoms bonded together, forming a variety of energy-rich compounds called hydrocarbons. During the petroleum refining process, engineers remove impurities such as sulfur, which can form sulfur dioxide and cause acid rain. Then, substances are added to improve the gasoline's performance and achieve the desired octane number, according to the U.S. Environmental Protection Agency. Octane numbers represent how much compression the gasoline can handle. The higher number, the less likely it is to ignite from the pressure.

With the final, carefully calibrated product, the gasoline is composed of hundreds of different compounds — too many to even identify and characterize, Speight said.

However, this care in balancing the gasoline goes to waste if the gasoline is stored for too long, said Richard Stanley, a former chemical engineer for Fluor Corporation, an engineering firm headquartered in Irving, Texas, and Ascent Engineering, based in Houston.

"If you leave gasoline by itself, over time ... it just doesn't perform the way you think it's going to perform," Stanley said.

This is because, over time, "[t]he lighter hydrocarbons start evaporating out of gasoline," Stanley told Live Science. And your car engine may not be designed to handle the resultant gasoline, if left too long.

Additionally, the careful blends that are used to produce gasoline don't look the same throughout the year, according to experts. In the winter, companies produce a gasoline containing lighter hydrocarbons, making the liquid more volatile and therefore easier to ignite.

During the colder months, this blend makes it easier to start your car, Speight said. But in the summertime, the blend loses enough of the lighter hydrocarbons, leaving you with a different gas rating, according to Stanley. Summer gasoline contains heavier hydrocarbons to prevent excessive evaporation from the heat. This makes summer-blend gasoline difficult to ignite in the winter, Stanley said.

Aside from evaporation, "[gasoline] is like wine — once you take it out of the bottle, it starts going bad. It starts oxidizing away," Stanley said.

As some of the hydrocarbons in the gasoline evaporate, other hydrocarbons react with the oxygen in the air, Speight said. The gasoline then begins to form solids called gum. [The 10 Most Polluted Places on Earth]

"[O]nce [the bad gasoline] gets into the pipeline, that gum may separate out ... and maybe [it will] not block the gas line fully, but maybe [it will] start to block it," Speight said.

"You can almost say that gumming of the gas lines is like atherosclerosis," he added, which is a disease in which cholesterol plaques build up in arteries.

In short, you want to store your gasoline in cool, low-oxygen environments, Speight said.

Additionally, one of the other main ingredients in gasoline in the United States is ethanol. In fact, most of the gasoline sold in the United States is made up of 10 percent ethanol, or a blend called E10, according to the U.S. Energy Information Administration. In the Midwest, the heartland of ethanol production, the blend can go as high as E85, or 85 percent ethanol.

However, unlike hydrocarbons, ethanol is hydrophilic, meaning it bonds to water.

"If there's ethanol in your gasoline, it could start sucking in water vapor from the air and putting it into your gasoline," Stanley said. "You don't want water in your engine, because it starts corroding the system."

All in all, while the experts agree there are too many variables to determine exactly when gasoline goes bad, they all urge caution with handling and storing gasoline.

"Remember, gasoline is very, very volatile," Speight said. "It's not worth trying to store large amounts. It can just result in trouble.

"Anything that makes the gasoline a little more volatile than it normally is affects the gasoline," he added. This includes temperature, humidity or, as Speight joked, "on a hot day ... looking at the stuff the wrong way."

AG MECHANICS & CHEMISTRY

Lesson 3

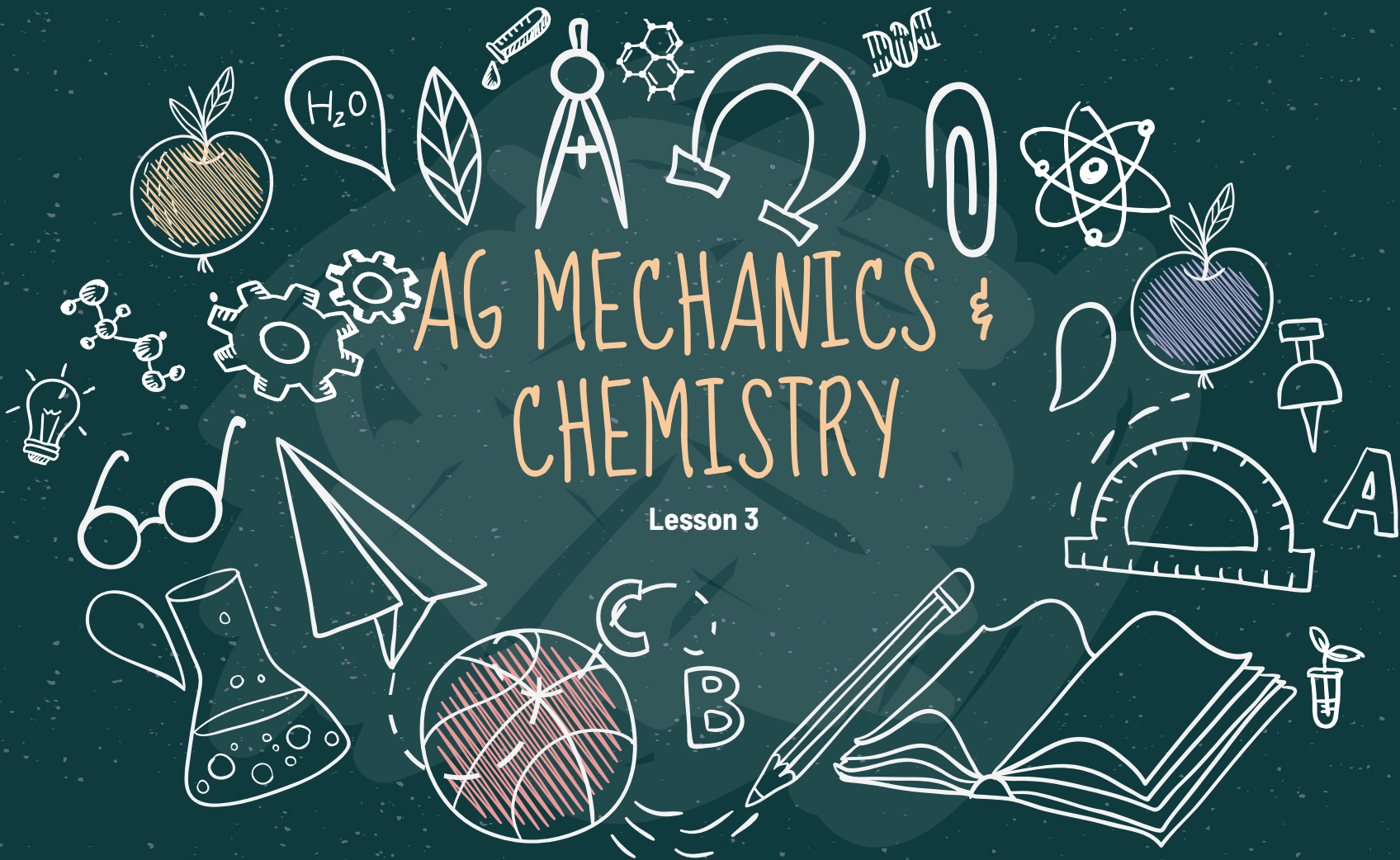

☆
 $\sqrt{123}$

☆
UNDERSTANDING
☆
FUEL CONDITIONS
☆



☆
STUDY
HARD!
☆

☆
+ x ÷

THE GOAL OF THIS PRESENTATION:

Accomplish this Standard:

HS-PS1-5 Apply scientific principles and evidence to provide an explanation about the effects of changing the temperature or concentration of the reacting particles on the rate at which a reaction occurs.

1. Be able to:
 - a. Describe what bad gasoline is.
 - b. How bad gas forms
 - c. How changes in gas changes the composition of the gas and the effects it has on fuel delivery (the carburetor)



CAN FUEL GO BAD?

Let's Read: [Does Gasoline Go Bad?](#)

Let's Watch: [Does Gasoline Go Bad? Video 1/3](#)

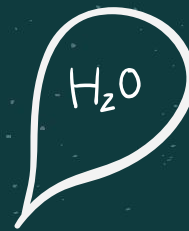

Turns out bad fuel is one of the most common problems with small engines. In fact fuel can go bad in a matter of four weeks.

-POWER EQUIPMENT DIRECT

www.powerequipmentdirect.com/stories/1410-How-to-Get-Your-Engine-Running-Again.html



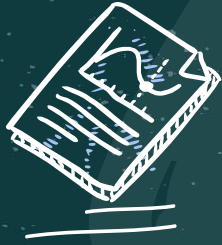

SO HOW DOES
FUEL GO BAD?

OXIDATION!!!!

FUEL GOES BAD DUE TO OXIDATION



Again we go back to the basic structure of an atom.

Oxygen has 8 protons and 8 electrons, but is one of the most electronegative of all the elements meaning that it has 8 protons allowing it to remain fairly positive in its charge which attracts electrons - causing oxidation as oxygen will attract/pull electrons from bonded atoms, that "gain" of oxygen is called oxidation.

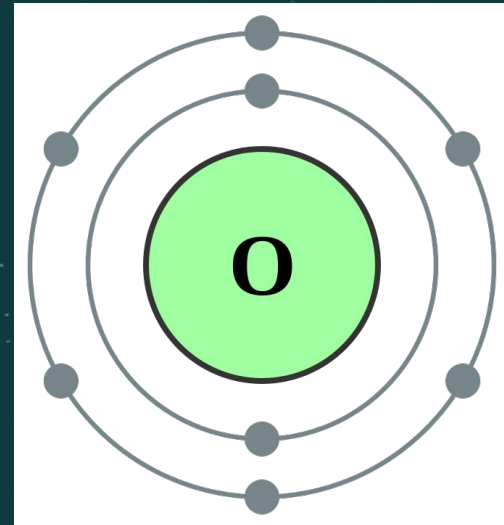

WHY IS OXIDATION BAD?



Gasoline that undergoes oxidation can result “in the change of coloration, the presence of non-volatile macromolecular substances (gum), as well as the development of particulate matter followed by sediment/deposit.” Additionally, all the products of the oxidation are less volatile and do not combust leading to reduced engine performance.

[Autoxidation of Fuels During Storage](#)

WHAT DOES OXIDATION MEAN FOR OUR ENGINES?



The products that cause oxidation can have huge effects on one key part of the engine.

Imagine the effects that sediment, deposits, and "gum" could have on a carburetor. That is why "bad gas" is one of the biggest issues with small engines. Additionally, we are no longer working with the same chemical reaction for combustion which will diminish how the combustion reaction will occur.





LET'S LEARN MORE ON CARBURETOR FUNCTION

Let's Watch: [How Carburetor Works - Main Fuel System](#) Video 1:08



LET'S EXPLORE POTENTIAL
CARBURETOR ISSUES IN THE
LAB!

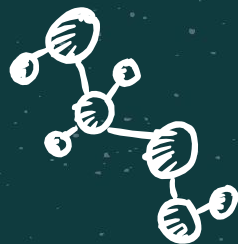

Carburetor Function Lab

Materials Needed:

- Briggs & Stratton Clear Carburetor
 - Purchase here:
<https://www.eetc.org/store/ListProducts.aspx?catid=379813>
- Shop Vac with “wet” capabilities
- Clear plastic tubing
 - Tubing to hook up to engine intake side of carburetor
 - Tubing to hook up mock fuel line.
- Hose Clamps
 - Clamps will be needed for all the tubing you will be using
- Fluorescent Liquid
 - Instructions here:
<https://sciencedipity.co.uk/glowing-fluorescent-liquid-highlighter-pen/>
- Container or old fuel tank to hold fluorescent liquid
- Scotch tape to partially block off carburetor passage ways to imitate particulates from using bad gas.

Instructions:

1. Follow the protocol at the link above to make the fluorescent liquid (this will represent our fuel).
2. Connect tubing to the carburetor to allow for the “fuel” to be pulled through the carburetor from suction induced by the Shop Vac.
3. Once situated and the fluorescent liquid is flowing to the bowl on the carburetor, start the shop vac to demonstrate how the carburetor works.
4. After showing how a carburetor works normally ask students how they would like to manipulate the carburetor to represent “bad gas” being used. We can accomplish this by using scotch tape to partially block passageways.

This video shows the intent of the lab: [Clear Carburetor Demonstration](#)

Agricultural Mechanics

Title of Unit:	Ag Mechanics & Chemistry
Title of Lesson:	<i>Describing Engines & their Energy</i>
Situation:	<i>This lesson is designed to be applied to an Agricultural Mechanics classroom and is the final lesson in a four lesson series embedding NGSS science standards in agricultural mechanics' curriculum. This lesson will outline the basic operations of a four stroke engines and have students describe the forms of energy performed by an engine.</i>
Housekeeping:	<i>Announcements, attendance, reminders, etc.</i>
Objective(s):	Students will be able to identify components of a four stroke engine and their function. Students will also be able to identify the energy changes that are taking place during an engines function.
CTE Standards:	N/A
Core Standards:	<i>HS-PS3-1 Create a computational model to calculate the change in the energy of one component in a system when the change in energy of the other component(s) and energy flows in and out of the system are known.</i> <i>HS-PS3-2 Develop and use models to illustrate that energy at the macroscopic scale can be accounted for as a combination of energy associated with the motions of particles (objects) and energy associated with the relative position of particles (objects).</i>
Materials:	<i>Students:</i> <ul style="list-style-type: none">○ <i>Note-taking materials</i> <i>Teacher:</i> <ul style="list-style-type: none">○ <i>Understanding Fuel Conditions Slides Presentation</i>○ <i>Reading/Assignment: "Forms of Energy" print enough copies for student class size</i>○ <i>Computer with internet connectivity</i>○ <i>Projector and Projection Screen</i>○ <i>Speakers to share videos</i>
References:	

Video: 4 Stroke Engine Theory/Briggs & Stratton -
<https://www.youtube.com/watch?v=kMCfZL9HgSk&feature=youtu.be>

Reading/Assignment – adapted to Google Doc accessed at -
<https://www.eia.gov/energyexplained/what-is-energy/forms-of-energy.php>

Interest Approach: *Place a small engine at the front of the classroom. Initiate discussion on what it is and how it might work.*

Student/Teacher

Planning:

What is the Problem?

Students are not familiar with the components and operation of small engines and their energy.

Why is it important we solve it?

Small engines are a part of everyday life. Additionally, principles of energy are involved in engine operation.

How should we solve it?

Explore the anatomy of small engines and how they work in relationship to energy.

Problem Solution: *How you teach it and what you teach*

Teacher Task	Instructions/Guidance
Interest Approach (5 minutes)	Place a small engine at the front of the classroom. Initiate discussion on what it is and how it might work.
Student/Teacher Planning (5 minutes)	After working students through the interest approach, discuss that engines consist of many components to make them run and that their main purpose is to create energy.
Describing Engines and their Energy Presentation - Google Slides (45 minutes)	Work through this 20 slide presentation with students. One video is embedded, to assist in explaining the function of a four stroke engine. Students are expected to take notes, teacher will hone in on specific topics of importance for their student to learn.

Applying Solutions: *How students can practice what you taught*

Teacher Task	Instructions/Guidance
Forms of Energy Poster/Presentation Assignment	Students will review the Google Doc outlining the forms of energy and then will create a poster or

(Two 50 minute class periods)	presentation that will outline the types of energy incorporated in the function of a four stroke engine.
-------------------------------	--

Evaluation:

How you assess what they learn: Students can be asked to describe engine function and how energy is used in the operation of an engine. This could be done as an assignment, formative assessment or be asked on a test.

AG MECHANICS & CHEMISTRY

Lesson 4

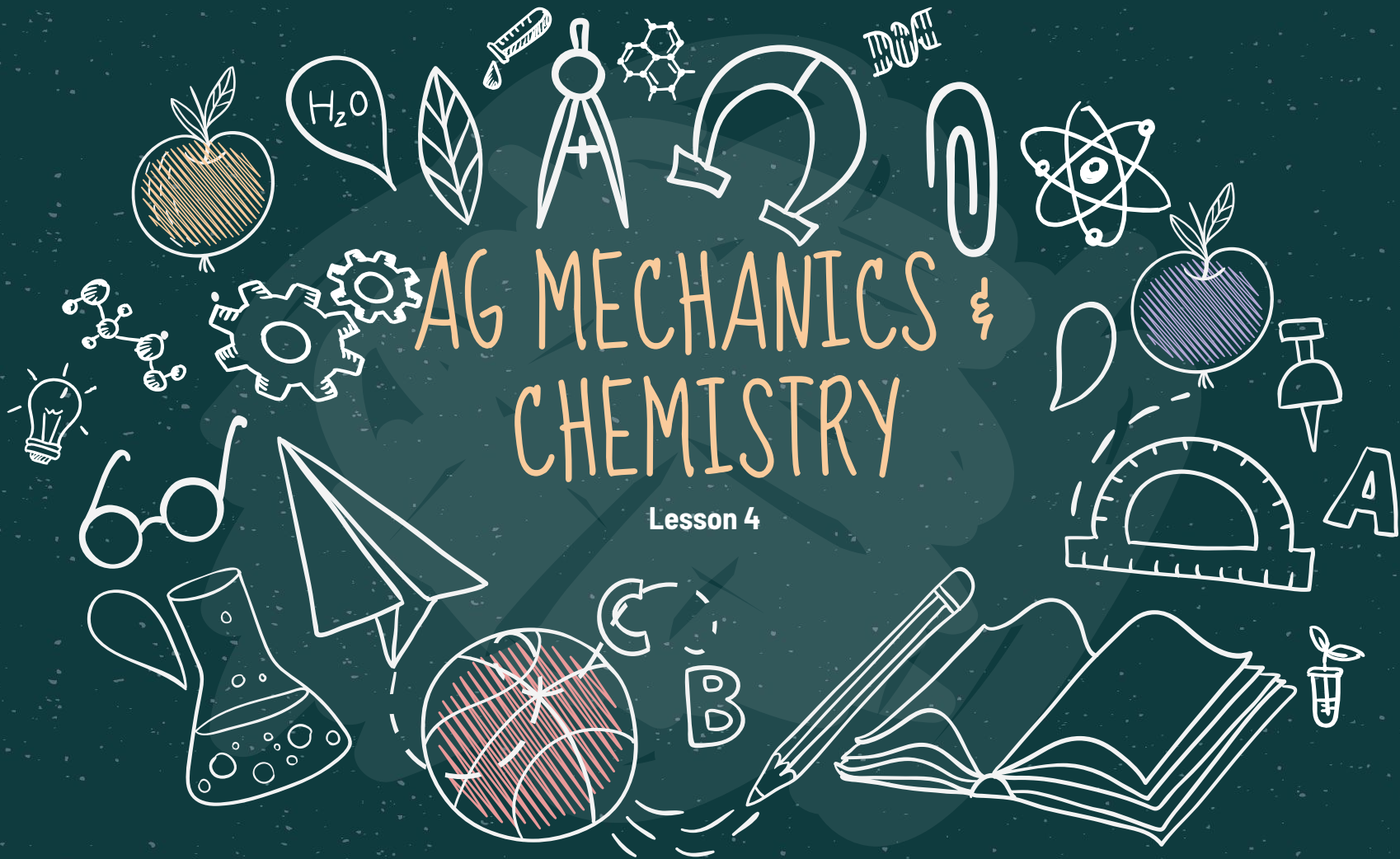

☆
 $\sqrt{123}$



☆ DESCRIBING ☆
ENGINES & THEIR ☆
ENERGY ☆

STUDY
HARD!

☆
+ x ÷

THE GOAL OF THIS PRESENTATION:

Accomplish these Standards:

HS-PS3-1 Create a computational model to calculate the change in the energy of one component in a system when the change in energy of the other component(s) and energy flows in and out of the system are known.

HS-PS3-2 Develop and use models to illustrate that energy at the macroscopic scale can be accounted for as a combination of energy associated with the motions of particles (objects) and energy associated with the relative position of particles (objects).

1. Be able to:
 - a. Identify the parts of a four stroke engine and how they work.
 - b. Discuss how energy is changed or utilized throughout the system of a small engine.



THE GOAL OF ENGINES

Is to convert chemical energy (fuel) into mechanical energy that can be used to power numerous applications

ENGINES CAN BE COMPLEX
SO LET'S HEAR IT FROM THE
PROFESSIONALS FIRST:



4 Stroke Engine Theory | Briggs & Stratton Video 10:04

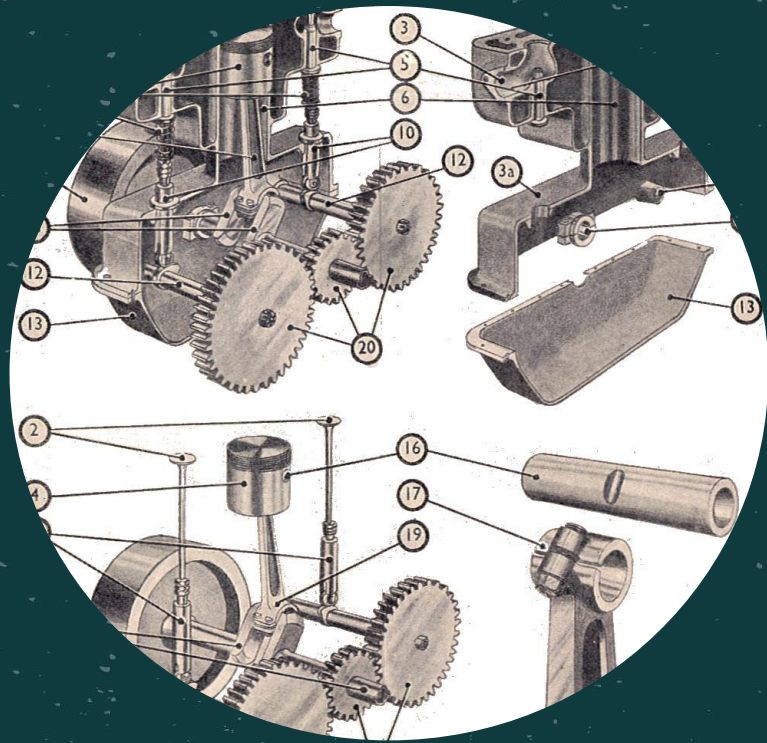

A FOUR CYCLE ENGINE
OPERATES THROUGH A SERIES
OF FOUR STROKES OR
MOVEMENTS OF THE PISTON



CYLINDER

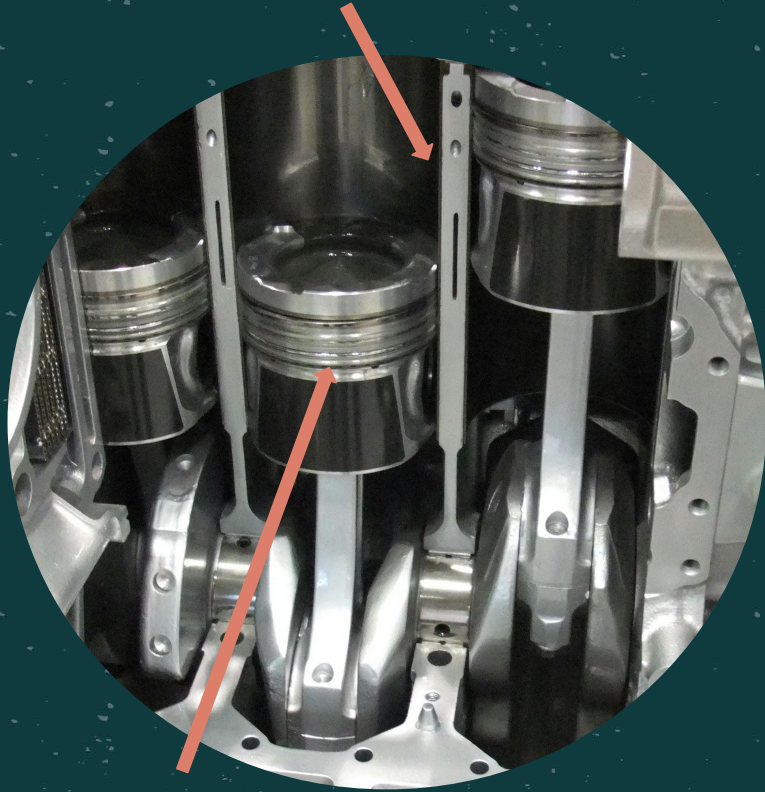

PISTON

INSIDE THE CYLINDER THE
PISTON MOVES IN AN UP AND
DOWN OR A BACK AND FORTH
MOTION



CRANKSHAFT

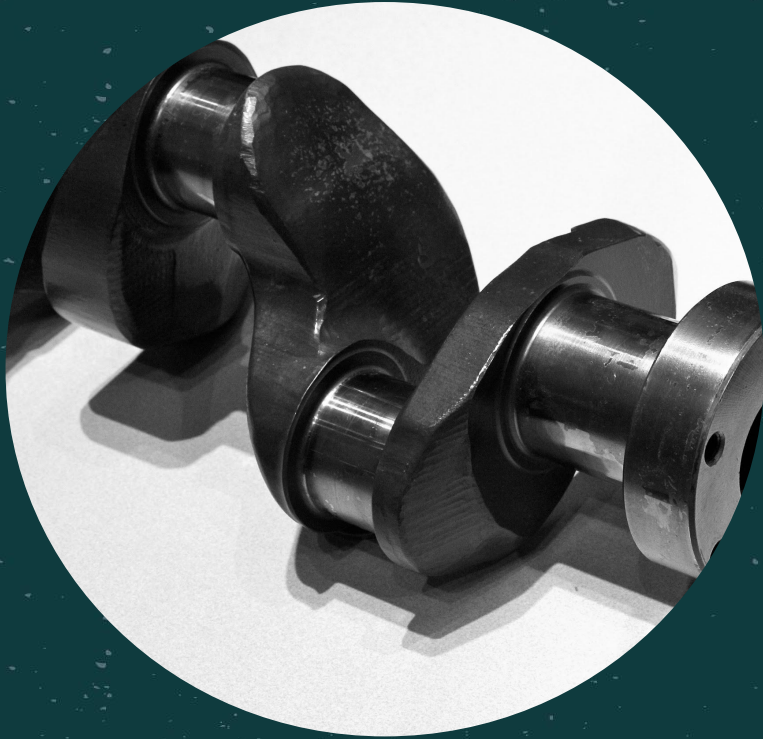

THE PISTON CONNECTS TO A CRANKSHAFT THAT CONVERTS THE UP AND DOWN MOTION OF THE PISTON INTO A ROTARY MOTION - POWERING THE INTENDED IMPLEMENT.



CRANKCASE

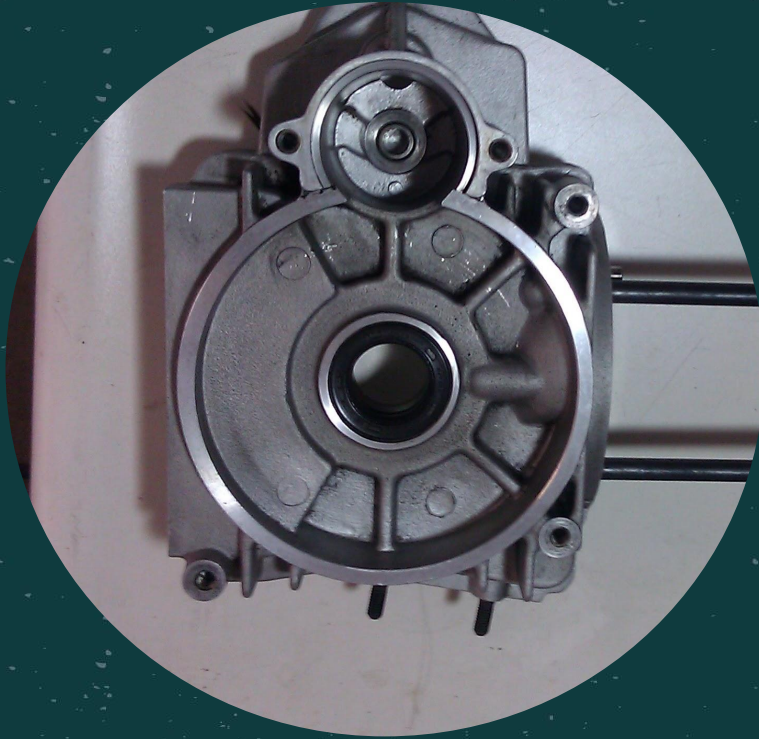

THE CRANKSHAFT IS HOUSED
IN THE CRANKCASE AND IS
ATTACHED TO THE FLYWHEEL
AT ONE END AND A
TRANSMISSION, GEAR, BLADE (THINK
MOWER), OR PULLEY AT THE OTHER
END.



ENGINE BLOCK



PISTON

VALVES

INTAKE VALVES LET THE FUEL MIXTURE INTO
THE COMBUSTION CHAMBER AND EXHAUST
VALVES LET FUMES OUT.

THE ENGINE BLOCK IS THE
MAIN CASTING OF THE ENGINE
AND CONTAINS THE VALVES
AND TYPICALLY THE CYLINDER
AND PISTON ARE HOUSED HERE
AS WELL.



CAMSHAFT

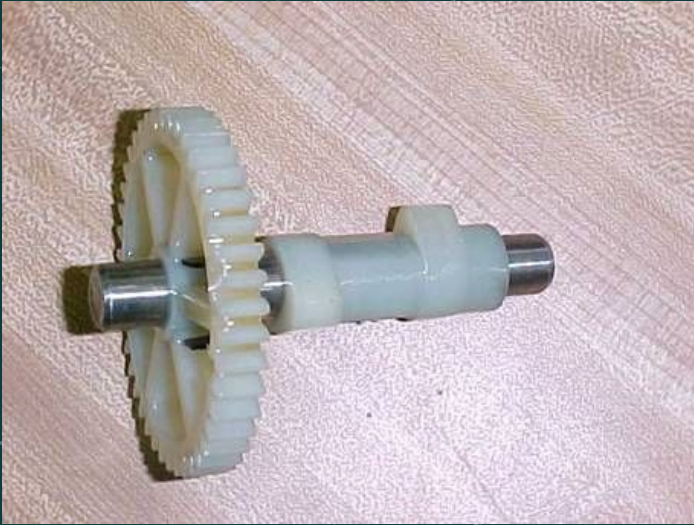

THE MOVEMENT OF VALVES IS
CONTROLLED BY THE CAMSHAFT
- WHICH IS POWERED BY THE
CRANKSHAFT.



SPARK PLUG



A SPARK PLUG IGNITES THE FUEL MIXTURE IN THE ENGINE, THE BURNING OF THE GASES PROVIDE THE FORCE TO DRIVE THE PISTON.



FLYWHEEL



SPARK FOR THE SPARK PLUG
COMES FROM ELECTRICITY,
SPECIFICALLY ELECTRICAL
INDUCTION, STARTING WITH
THE FLYWHEEL WHICH IS
EQUIPPED WITH A MAGNET.



FLYWHEEL

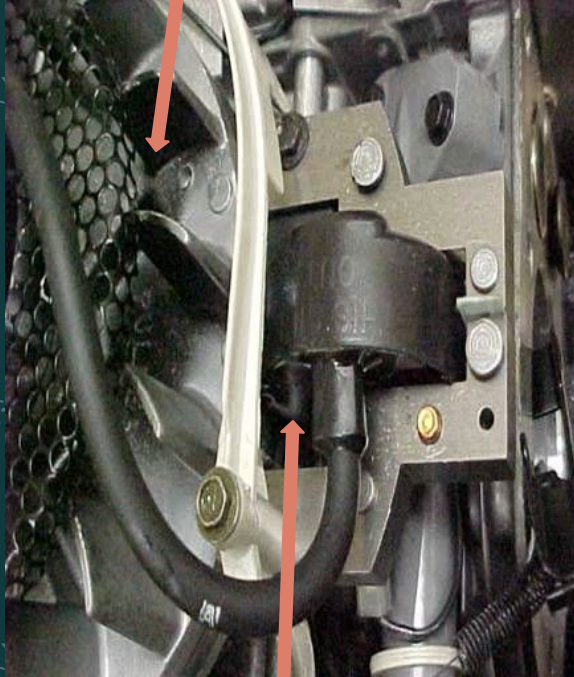

ARMATURE

THE MAGNET ON THE FLYWHEEL
PASSES AN ARMATURE WHICH
CREATES A CURRENT ON AN
ELECTRICAL CIRCUIT. TIMING
OF THE ENGINE ALLOWS THE
CIRCUIT TO OPEN INITIATING
THE SPARK OF THE SPARK PLUG



FOUR STROKES OF A FOUR CYCLE ENGINE:

1. INTAKE STROKE
2. COMPRESSION STROKE
3. POWER STROKE
4. EXHAUST STROKE

WITH A KNOWLEDGE OF THE
BASIC ENGINE PARTS WE COME
TO THE FOUR STROKES OF THE
ENGINE REQUIRED TO
COMPLETE ONE CYCLE.



INTAKE EVENT

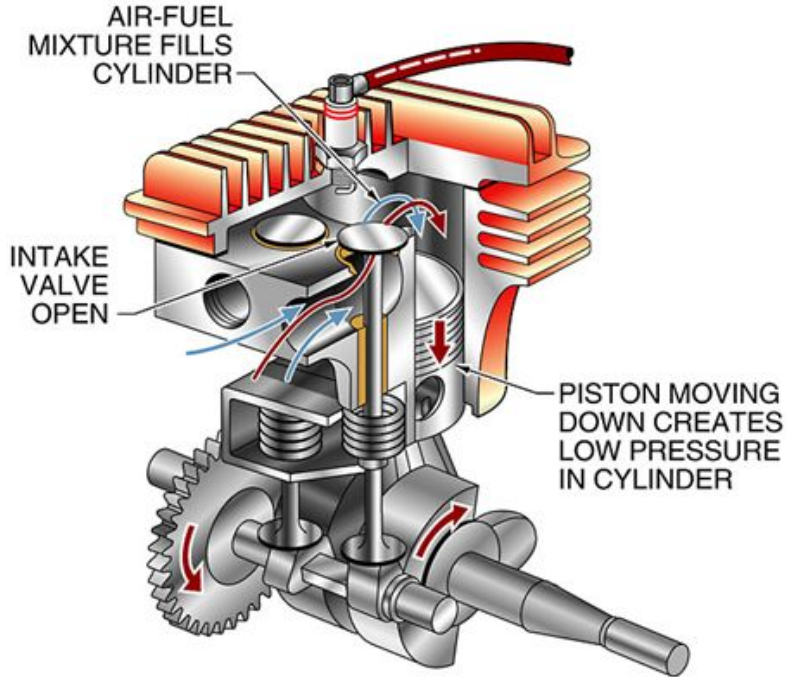

During the Intake Stroke the air/fuel mixture is taken into the combustion chamber. This occurs as a low pressure is created from the piston traveling from Top Dead Center (TDC) to Bottom Dead Center (BDC)



COMPRESSION EVENTS

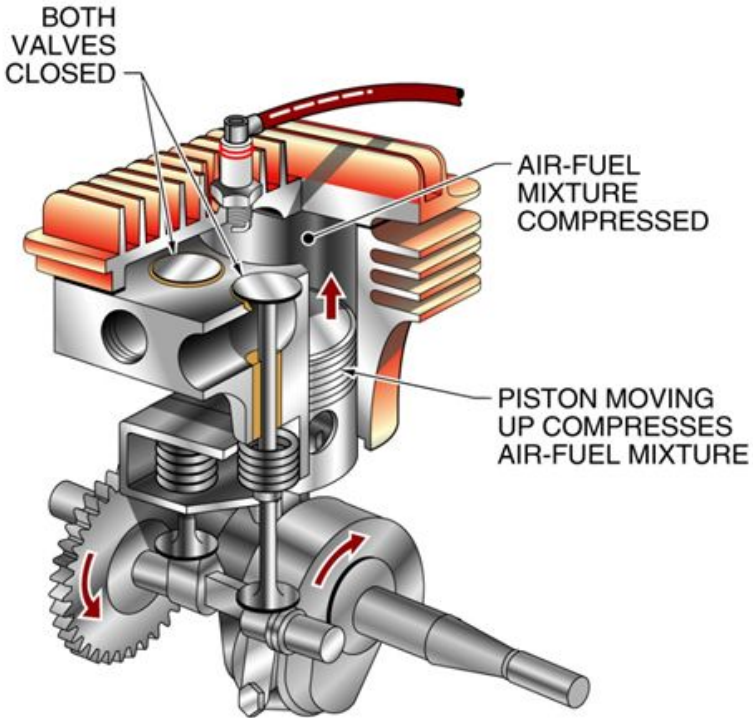

During the Compression Stroke the trapped air/fuel mixture is compressed as the piston travels back up from Bottom Dead Center (BDC) to Top Dead Center (TDC)



POWER EVENTS

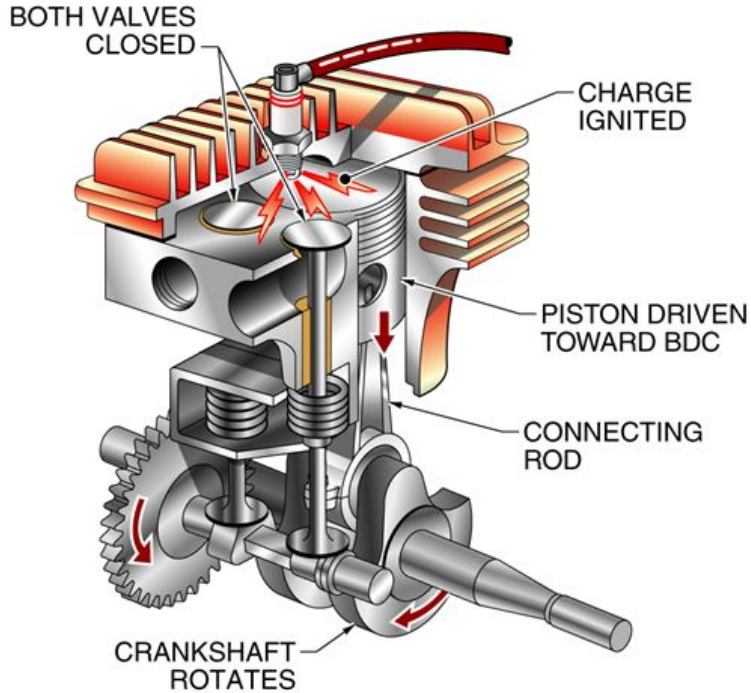

The Power Stroke is when the spark occurs igniting the air/fuel mixture. The ignited expanding gases then force the piston to travel down the cylinder.



EXHAUST EVENT

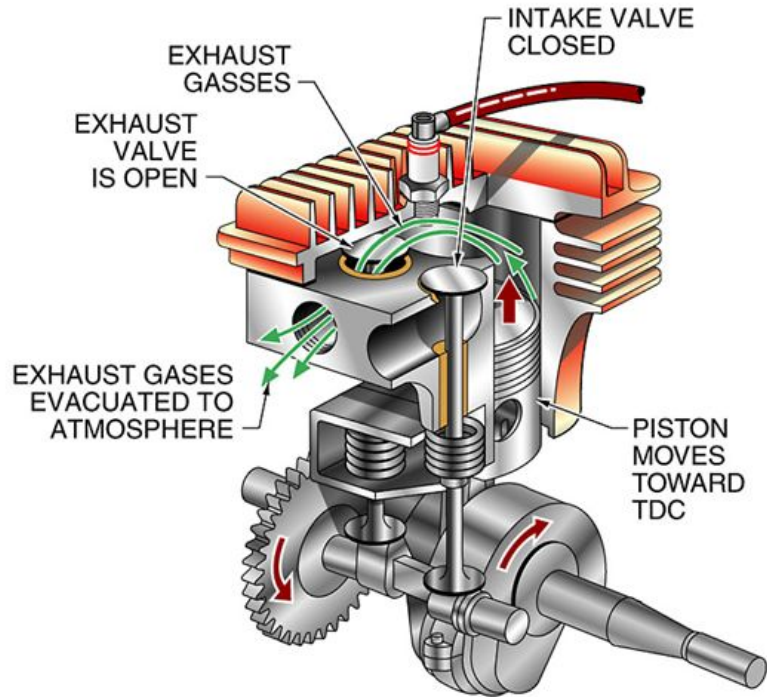

The Exhaust Stroke is where we see the exhaust gases forced out to exit the engine. This happens as the piston travels from Bottom Dead Center (BDC) to Top Dead Center (TDC) and the exhaust valve is opened on the engine block.



ENERGY IN SMALL ENGINES



Let's evaluate the forms of energy that occur in the operation of small engines.

Forms of Energy

CREATE A MODEL (POSTER) TO EXPLAIN WHAT IS HAPPENING IN REGARDS TO ENERGY AS THE ENGINE OPERATES.

https://medium.com/@shishir_ayer/why-is-oxygen-electronegative-61647c8a3ed

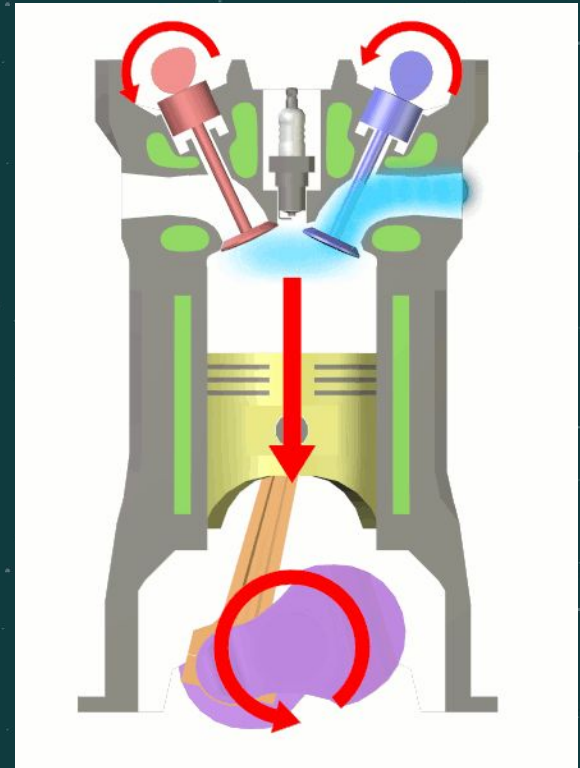

What is Energy?

Forms of Energy

Many forms of energy exist, but they all fall into two basic categories:

- Potential energy
- Kinetic energy

Potential Energy

Potential energy is stored energy and the energy of position.

Chemical energy is energy stored in the bonds of atoms and molecules. Batteries, biomass, petroleum, natural gas, and coal are examples of chemical energy. Chemical energy is converted to thermal energy when people burn wood in a fireplace or burn gasoline in a car's engine.

Mechanical energy is energy stored in objects by tension. Compressed springs and stretched rubber bands are examples of stored mechanical energy.

Nuclear energy is energy stored in the nucleus of an atom—the energy that holds the nucleus together. Large amounts of energy can be released when the nuclei are combined or split apart.

Gravitational energy is energy stored in an object's height. The higher and heavier the object, the more gravitational energy is stored. When a person rides a bicycle

down a steep hill and picks up speed, the gravitational energy is converting to motion energy. Hydropower is another example of gravitational energy, where gravity forces water down through a hydroelectric turbine to produce electricity.

Kinetic Energy

Kinetic energy is the motion of waves, electrons, atoms, molecules, substances, and objects.

Radiant energy is electromagnetic energy that travels in transverse waves. Radiant energy includes visible light, x-rays, gamma rays, and radio waves. Light is one type of radiant energy. Sunshine is radiant energy, which provides the fuel and warmth that make life on earth possible.

Thermal energy, or heat, is the energy that comes from the movement of atoms and molecules in a substance. Heat increases when these particles move faster. Geothermal energy is the thermal energy in the earth.

Motion energy is energy stored in the movement of objects. The faster they move, the more energy is stored. It takes energy to get an object moving, and energy is released when an object slows down. Wind is an example of motion energy. A dramatic example of motion energy is a car crash—a car comes to a total stop and releases all of its motion energy at once in an uncontrolled instant.

Sound is the movement of energy through substances in longitudinal (compression/rarefaction) waves. Sound is produced when a force causes an object or

substance to vibrate. The energy is transferred through the substance in a wave. Typically, the energy in sound is smaller than in other forms of energy.

Electrical energy is delivered by tiny charged particles called electrons, typically moving through a wire. Lightning is an example of electrical energy in nature.

Last updated: June 17, 2020

ASSIGNMENT:

Utilizing what you have just learned about engine operation and the components of an engine you are to design a poster or presentation that highlights the types of energy that are occurring during engine operation. Your presentation must include pictures or graphics detailing the energy types you are trying to describe that are tied to engine component functions. Be creative and identify as many forms of energy that you can!